

Current Sensor

Product Series: STK-CTS/P5

Part number: STK-25CTS/P5
STK-32CTS/P5
STK-40CTS/P5
STK-50CTS/P5

Version: Ver1.7

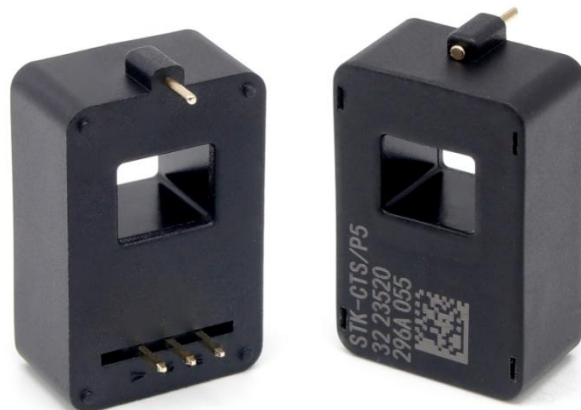

Sinomags Technology Co., Ltd

Web site : www.sinomags.com

CONTENT

1.	Description.....	2
2.	Electrical data STK-25CTS/P5.....	3
3.	Electrical data STK-32CTS/P5.....	3
4.	Electrical data STK-40CTS/P5.....	4
5.	Electrical data STK-50CTS/P5.....	6
6.	Frequency band width.....	7
7.	Response time & noise with typical circuit.....	7
8.	Frequency delay performace.....	8
9.	STK-CTS/P5 Dimensions & Pins & Footprint.....	9

1. Description

The STK-CTS/P series current sensor is based on TMR (tunnel magnetoresistance) technology and open-loop design. It is suitable for DC, AC pulsed and any kind of irregular current measurement under the isolated conditions.

Typical applications

- AC Variable speed drives
- Inverter
- Electric welder power supply
- Switched model power supplies (SMPS)

General parameter

Parameter	Symbol	Unit	Value
Working temperature	T_A	°C	-40 ~ 105
Storage temperature	T_stg	°C	-40 ~ 105
Mass	m	g	10
Maximum traverse temperature	T_mt	°C	105

Remark 1: The product will not be damaged when used at 105 °C

Absolute maximum rating

Parameter	Symbol	Unit	Value
Supply voltage	V _{cc}	V	6
ESD rating (HBM)	U _{ESD}	kV	4

Remark 2: the unrecoverable damage may occur when the product works on the conditions over the absolute maximum ratings. Long-time working on the absolute maximum ratings may cause the degradation on performance and reliability.

Isolation parameter

Parameter	Symbol	Unit	Value	Comment
RMS voltage for AC test 50Hz/1 min	U _d	kV	4	
Impulse withstand voltage 1.2/50μs	Ū _w	kV	6	
Clearance distance (pri. -sec)	d _{Cl}	mm	> 8	Space shortest distance
Creepage distance (pri. -sec)	d _{Cp}	mm	> 8	Shortest distance along the body
Shell material			V0 according to UL 94	

2. Electrical data STK-25CTS/P5

 Condition: $T_A = 25^\circ\text{C}$, $V_{cc} = 5\text{V}$

Parameter	Symbol	Unit	Min	Typ	Max	Comment
Primary nominal current	I_{pn}	A	-10		10	
Primary current measuring range	I_{pm}	A	-25		25	
Supply voltage	V_{cc}	V	4.75	5	5.25	
Current consumption	I_{cc}	mA		5	10	
Rated output voltage	V_{FS}	V		± 0.8		$(V_{out} @ \pm I_{pn}) - V_{off}$
Internal output resistance	R_{out}	Ω		1		@ V_{out}
Quiescent voltage	V_{off}	V	2.48	2.5	2.52	$V_{out} @ 0\text{A}$
Theoretical gain	G_{th}	mV/A		80		0.8 V @ I_{pn}
Non-linearity	Non-L	% I_{pn}		0.5		$\pm I_{pn}$
reaction time	t_{ra}	μs		0.5		@10% of I_{PN}
Step response time	t_{res}	μs		1		@90% of I_{PN}
Delay time	t_{delay}	μs		1		@400 kHz
-3dB band width	BW	kHz		400		Back-end non-RC circuit
Noise DC ~ 10 kHz DC ~ 100 kHz	V_{noise}	mVpp		15 25		
Accuracy @ RT	X	% of I_{pm}	-0.8		0.8	@ 25°C When $I_{pn} < I < I_{pm}$ $\Delta I (max) \leq 0.2\text{A}$
Accuracy	X_{TRange}	% of I_{pm}	-1.5		1.5	@ $-40^\circ\text{C} \sim 85^\circ\text{C}$ When $I_{pn} < I < I_{pm}$ $\Delta I (max) \leq 0.375\text{A}$
Accuracy	X_{TRange}	% of I_{pm}	-3		3	@ $85^\circ\text{C} \sim 105^\circ\text{C}$ When $I_{pn} < I < I_{pm}$ $\Delta I (max) \leq 0.75\text{A}$

Note:

- Accuracy @ RT, $X = ((V_{out} @ I_n @ 25^\circ\text{C}) - (G_{fit} * I_n + V_{off} @ 25^\circ\text{C})) / V_{FS}$, Here I_n is the current test current. G_{fit} is the normal temperature fitting gain.
- Accuracy, $X_{TRange} = ((V_{out} @ I_n @ T_x) - (G_{fit@25^\circ\text{C}} * I_n + V_{off} @ 25^\circ\text{C})) / V_{FS}$, The fitting gain of the product at $G_{fit@25^\circ\text{C}}$ is 25°C .

3. Electrical data STK-32CTS/P5

 Condition: $T_A = 25^\circ\text{C}$, $V_{cc} = 5\text{V}$

Parameter	Symbol	Unit	Min	Typ	Max	Comment
Primary nominal current	I _{pn}	A	-12.8		12.8	
Primary current measuring range	I _{pm}	A	-32		32	
Supply voltage	V _{cc}	V	4.75	5	5.25	
Current consumption	I _{cc}	mA		5	10	
Rated output voltage	V _{FS}	V		±0.8		(V _{out} @ ±I _{pn}) – V _{off}
Internal output resistance	R _{out}	Ω		1		@V _{out}
Quiescent voltage	V _{off}	V	2.48	2.5	2.52	V _{out} @ 0 A
Theoretical gain	G _{th}	mV/A		62.5		0.8 V @ I _{pn}
Non-linearity	Non-L	%I _{pn}		0.5		±I _{pn}
reaction time	t _{ra}	μs		0.5		@10% of I _{PN}
Step response time	t _{res}	μs		1		@90% of I _{PN}
Delay time	t _{delay}	μs		1		@400 kHz
-3dB band width	BW	kHz		400		Back-end non-RC circuit
Noise DC ~ 10 kHz DC ~ 100 kHz	V _{noise}	mVpp		15 25		
Accuracy @ RT	X	% of I _{pm}	-0.8		0.8	@ 25°C When I _{pn} < I < I _{pm} Δ I (max) ≤ 0.256A
Accuracy	X _{TRange}	% of I _{pm}	-1.5		1.5	@ -40°C ~ 85°C When I _{pn} < I < I _{pm} Δ I (max) ≤ 0.48A
Accuracy	X _{TRange}	% of I _{pm}	-3		3	@ 85°C ~ 105°C When I _{pn} < I < I _{pm} Δ I (max) ≤ 0.96A

Note:

1. Accuracy @ RT, X = ((V_{out} @ I_n @ 25°C) – (G_{fit} * I_n + V_{off} @ 25°C)) / V_{FS}, Here I_n is the current test current. G_{fit} is the normal temperature fitting gain.

2. Accuracy, X_{TRange} = ((V_{out} @ I_n @ T_x) – (G_{fit}@25°C * I_n + V_{off} @ 25°C)) / V_{FS}, The fitting gain of the product at G_{fit}@25 °C is 25 °C.

4. Electrical data STK-40CTS/P5

Condition: T_A = 25°C, V_{cc} = 5 V

Parameter	Symbol	Unit	Min	Typ	Max	Comment
Primary nominal current	I _{pn}	A	-16		16	
Primary current measuring range	I _{pm}	A	-40		40	

Supply voltage	V _{cc}	V	4.75	5	5.25	
Current consumption	I _{cc}	mA		5	10	
Rated output voltage	V _{FS}	V		±0.8		(V _{out} @ ±I _{pn}) – V _{off}
Internal output resistance	R _{out}	Ω		1		@V _{out}
Quiescent voltage	V _{off}	V	2.48	2.5	2.52	V _{out} @ 0 A
Theoretical gain	G _{th}	mV/A		50		0.8 V @ I _{pn}
Non-linearity	Non-L	%I _{pn}		0.5		±I _{pn}
reaction time	t _{ra}	μs		0.5		@10% of I _{PN}
Step response time	t _{res}	μs		1		@90% of I _{PN}
Delay time	t _{delay}	μs		1		@400 kHz
-3dB band width	BW	kHz		400		Back-end non-RC circuit
Noise DC ~ 10 kHz DC ~ 100 kHz	V _{noise}	mVpp		15 25		
Accuracy @ RT	X	% of I _{pm}	-0.8		0.8	@ 25°C When I _{pn} < I < I _{pm} Δ I (max) ≤ 0.32A
Accuracy	X _{TRange}	% of I _{pm}	-1.5		1.5	@ -40°C ~ 85°C When I _{pn} < I < I _{pm} Δ I (max) ≤ 0.60A
Accuracy	X _{TRange}	% of I _{pm}	-3		3	@ 85°C ~ 105°C When I _{pn} < I < I _{pm} Δ I (max) ≤ 1.2A

Note:

1. Accuracy @ RT, X = ((V_{out} @ I_n @ 25°C) – (G_{fit} * I_n + V_{off} @ 25°C)) / V_{FS}, Here I_n is the current test current. G_{fit} is the normal temperature fitting gain.

2. Accuracy, X_{TRange} = ((V_{out} @ I_n @ T_x) – (G_{fit@25°C} * I_n + V_{off} @ 25°C)) / V_{FS}, The fitting gain of the product at G_{fit@25°C} is 25 °C.

5. Electrical data STK-50CTS/P5

 Condition: $T_A = 25^\circ\text{C}$, $V_{cc} = 5\text{V}$

Parameter	Symbol	Unit	Min	Typ	Max	Comment
Primary nominal current	I_{pn}	A	-20		20	
Primary current measuring range	I_{pm}	A	-50		50	
Supply voltage	V_{cc}	V	4.75	5	5.25	
Current consumption	I_{cc}	mA		5	10	
Rated output voltage	V_{FS}	V		± 0.8		$(V_{out} @ \pm I_{pn}) - V_{off}$
Internal output resistance	R_{out}	Ω		1		@ V_{out}
Quiescent voltage	V_{off}	V	2.48	2.5	2.52	$V_{out} @ 0\text{A}$
Theoretical gain	G_{th}	mV/A		40		$0.8\text{V} @ I_{pn}$
Non-linearity	Non-L	% I_{pn}		0.5		$\pm I_{pn}$
reaction time	t_{ra}	μs		0.5		@10% of I_{PN}
Step response time	t_{res}	μs		1		@90% of I_{PN}
Delay time	t_{delay}	μs		1		@400 kHz
-3dB band width	BW	kHz		400		Back-end non-RC circuit
Noise DC ~ 10 kHz DC ~ 100 kHz	V_{noise}	mVpp		15 25		
Accuracy @ RT	X	% of I_{pm}	-0.8		0.8	@ 25°C When $I_{pn} < I < I_{pm}$ $\Delta I \text{ (max)} \leq 0.4\text{A}$
Accuracy	X_{TRange}	% of I_{pm}	-1.5		1.5	@ $-40^\circ\text{C} \sim 85^\circ\text{C}$ When $I_{pn} < I < I_{pm}$ $\Delta I \text{ (max)} \leq 0.75\text{A}$
Accuracy	X_{TRange}	% of I_{pm}	-3		3	@ $85^\circ\text{C} \sim 105^\circ\text{C}$ When $I_{pn} < I < I_{pm}$ $\Delta I \text{ (max)} \leq 1.5\text{A}$

Note:

1. Accuracy @ RT, $X = ((V_{out} @ I_n @ 25^\circ\text{C}) - (G_{fit} * I_n + V_{off} @ 25^\circ\text{C})) / V_{FS}$, Here I_n is the current test current. G_{fit} is the normal temperature fitting gain.

2. Accuracy, $X_{TRange} = ((V_{out} @ I_n @ T_x) - (G_{fit@25^\circ\text{C}} * I_n + V_{off} @ 25^\circ\text{C})) / V_{FS}$, The fitting gain of the product at $G_{fit@25^\circ\text{C}}$ is 25°C .

6. Frequency band width

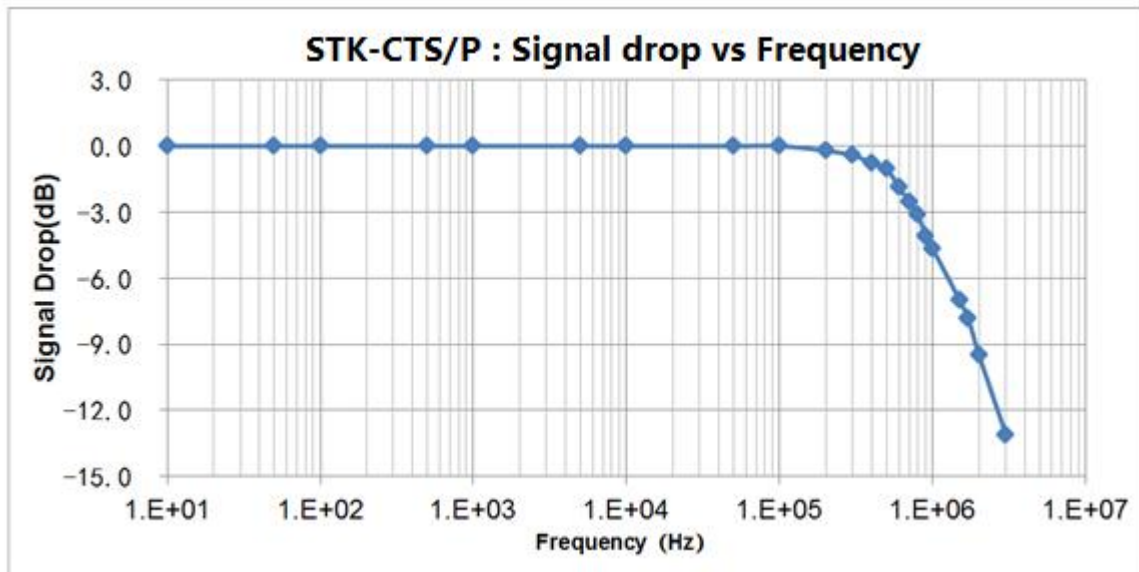

Fig.1 the band width of STK-CTS/P series current sensors. The bandwidth of the sensor is in the range of DC ~400 kHz (-3 dB).

7. Response time & noise with typical circuit

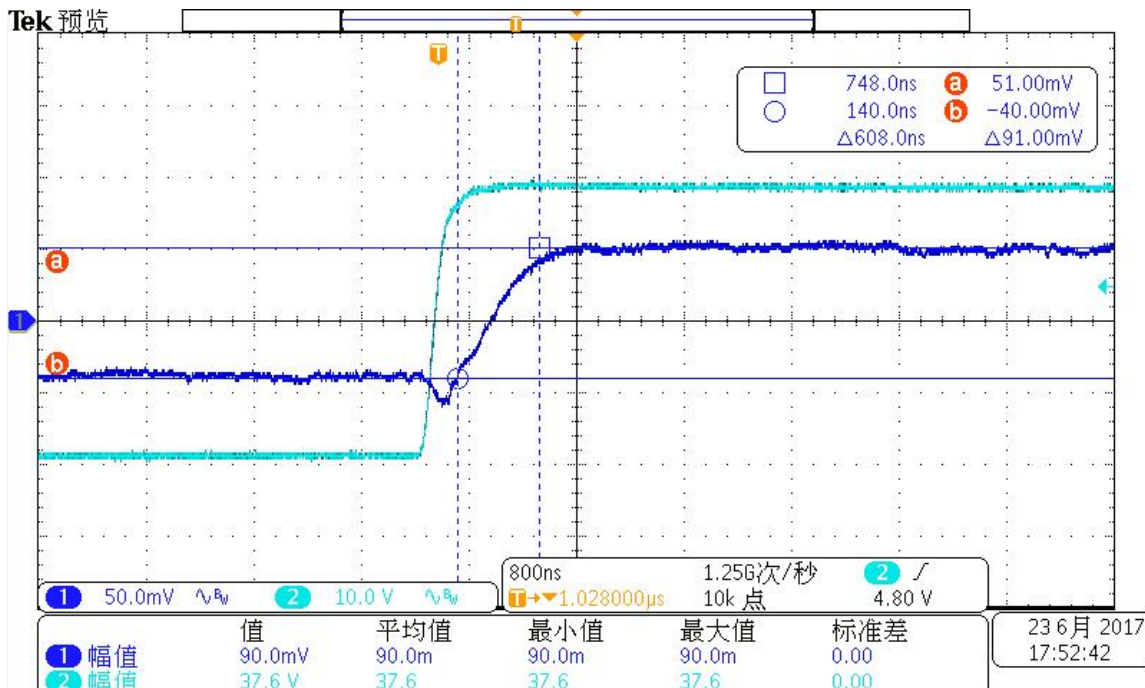

Fig.2 the step response time of STK-CTS/P current sensors. The light blue is primary current, while the dark blue is output signal of current sensor. The delay from 90% of the original current signal to 90% of the output of the sensor is less than 1us.

8. Frequency delay performace

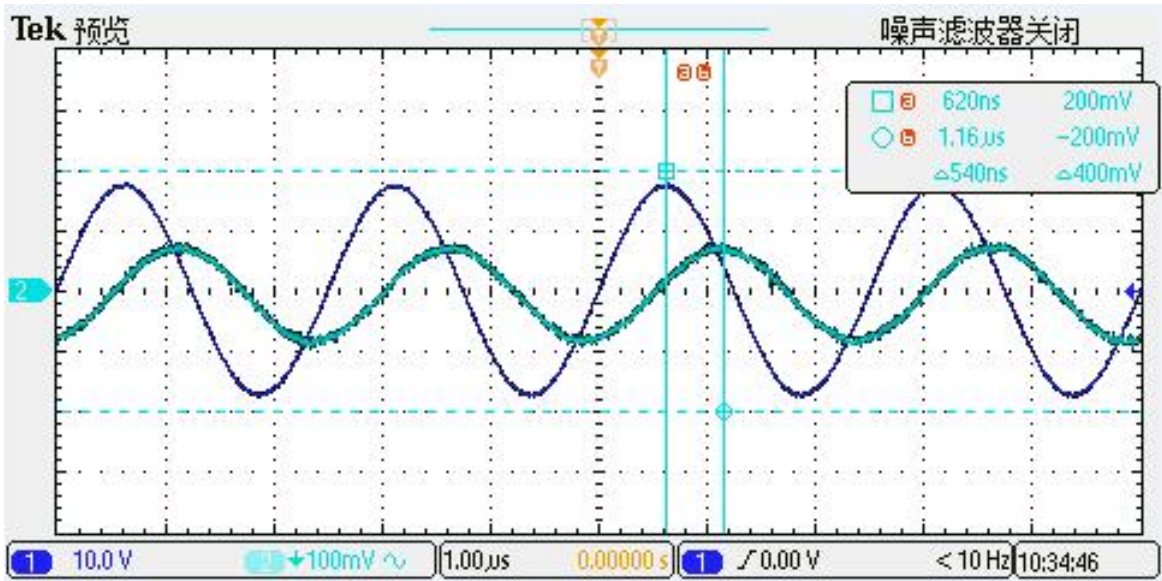
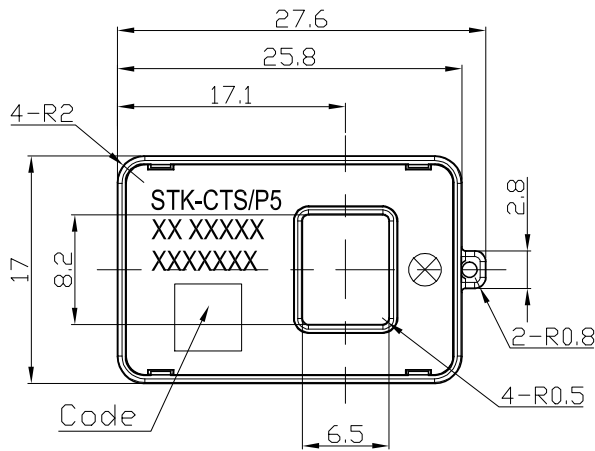
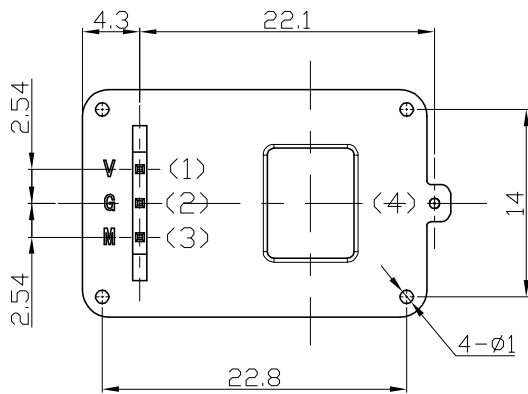
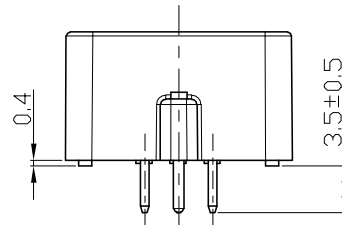
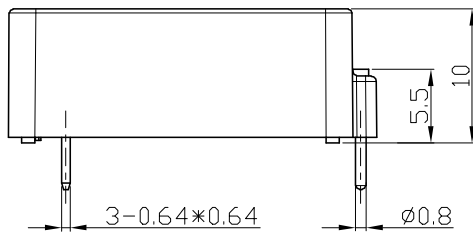
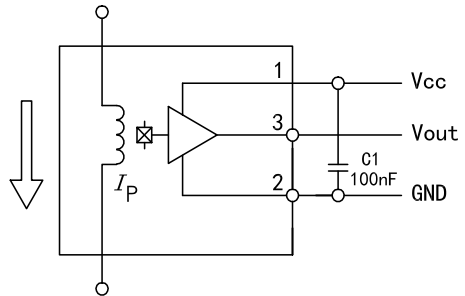

Fig.3 when detection the primary current with a frequency of 400 kHz. The typical results of the output of STK-CTS/P current sensor on the primary current delay characteristics. The delay time from primary current (light blue) to the output of the sensor (dark blue) is less than us.

9. STK-CTS/P5 Dimensions & Pins & Footprint



Connection



Terminals

(1)	Vcc
(2)	GND
(3)	Vout
(4)	NULL

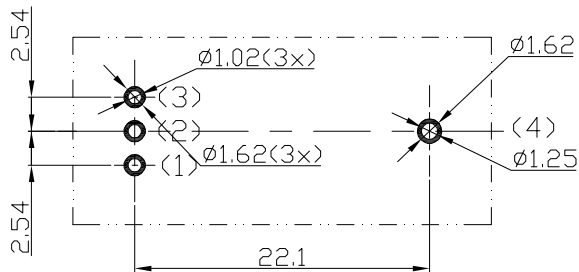

Material : Fit UL94V-0 & RoHS requirements ;
 General tolerance : ± 0.5
 Unit :mm

