

CURRENT SENSOR

PRODUCT SERIES: STK-HD/P1/x

PRODUCT PART NUMBER: STK-30HD/P1/1 , STK-20HD/P1/1 ,
STK-20HD/P1/2

REVISION: Ver 1.6

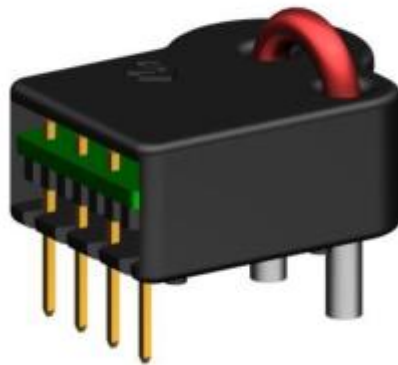

Sinomags Technology Co., Ltd.

Web site: www.sinomags.com

CONTENT

1.	Description	2
2.	Electrical performance of STK-30HD/P1/1	3
3.	Output voltage VS primary current of STK-30HD/P1/1	4
4.	Electrical performance of STK-20HD/P1/1	5
5.	Output voltage VS primary current of STK-20HD/P1/1	8
6.	Electrical performance of STK-20HD/P1/2	7
7.	Output voltage VS primary current of STK-20HD/P1/2	8
8.	Frequency band width	9
9.	Step response time	9
10.	Delay time	10
11.	Accuracy performance	10
12.	Typical application circuits for STK-HD/P1/x	12
13.	Dimensions & Pins & Footprint	13

1. Description

STK-HD/P1/x current sensor is based on the open loop principle and TMR technology. DC, AC, pulses and any kind of irregularities wave can be measured by the current sensor under the isolated conditions.

Typical application

- AC Variable speed drives
- PV string current detection
- Switched model power supplies (SMPS)
- Direct-current dynamo
- MPPT

General parameters

Parameter	Symbol	Unit	Value
Working temperature	T _A	°C	-40 ~ 105
Storage temperature	T _{stg}	°C	-40 ~ 105
Mass	m	g	10

Absolute parameters

Parameters	Symbol	Unit	Value
Supply voltage	V _C	V	6
ESD rating (HBM)	U _{ESD}	kV	4

Remark: the unrecoverable damage may occur when the product works on the conditions over the absolute maximum ratings. Long-time working on the absolute maximum ratings may cause the degradation on performance and reliability.

Isolation parameters

Parameter	Symbol	Unit	Value	Remark
RMS voltage for AC test 50Hz/1 min	U _d	kV	4	
Impulse withstand voltage 1.2/50μs	Ū _w	kV	6	
Clearance distance (pri.-sec)	dCl	mm	9.6	Shortest distance through air
Creepage distance (pri.-sec)	dCp	mm	9.6	Shortest path along device body
Electrical clearance	-	mm	9	When mounted on PCB with recommended layout
Case material			V0 according to UL 94	
Comparative tracking index	CTI	V	600	

2. Electrical performance of STK-30HD/P1/1

Parameter	Symbol	Unit	Min	Typ	Max	Comment
Primary nominal current rms	I _{pn}	A		30		
Primary current measuring range	I _{pm}	A	-30		30	STK-30HD/P1/1
Supply voltage	V _{cc}	V	4.75	5	5.25	
Current consumption	I _{cc}	mA		5		
Reference voltage	V _{ref}	V	2.47	2.5	2.53	Output function
Quiescent voltage V _{out} @ 0 A	V _{off}	V	2.47	2.5	2.53	STK-30HD/P1/1
Electrical offset voltage (V _{out} – V _{ref}) @ 0 A	V _{oe}	mV	-30		30	STK-30HD/P1/1
Rated output voltage ((V _{out} – V _{ref})@ I _{pn}) – V _{oe}	V _{FS}	V		1.98		STK-30HD/P1/1
Internal output resistance	R _{out}	Ω		1		
Internal reference resistance	R _{ref}	Ω		1		
Theoretical gain	G	mV/A		66		STK-30HD/P1/1
Rated linearity error	Non-L	%I _{pn}		0.7		Within ±I _{pn}
Reaction time	t _{ra}	μs		0.5		@ 10% of I _{pn}
Step response time	t _{res}	μs		1.0		@ 90% of I _{pn}
Delay time	t _{delay}	μs		0.5		400 kHz sine wave
Frequency bandwidth (-3dB)	BW	kHz		600		No RC circuit
Output voltage noise DC ~ 10 kHz DC ~ 100 kHz	V _{noise}	mV _{pp}		15 20		@250 kHz Sampling Rate
Accuracy @ 25°C	X	% of I _{pn}	-1		1	@ 25°C
Accuracy @ -40°C~105°C	X _{TRange}	% of I _{pn}	-3		3	-40°C ~ 105°C

Remarks:

- the accuracy @ -40°C~105°C, X_{TRange} = (((V_{out} – V_{ref})@ I_n @ T_x) – V_{oe}@ 25°C – G_{th} * I_n) / V_{FS}, where T_x represents present temperature, G_{th} is fitted gain at room temperature.

3. Output voltage VS primary current of STK-30HD/P1/1

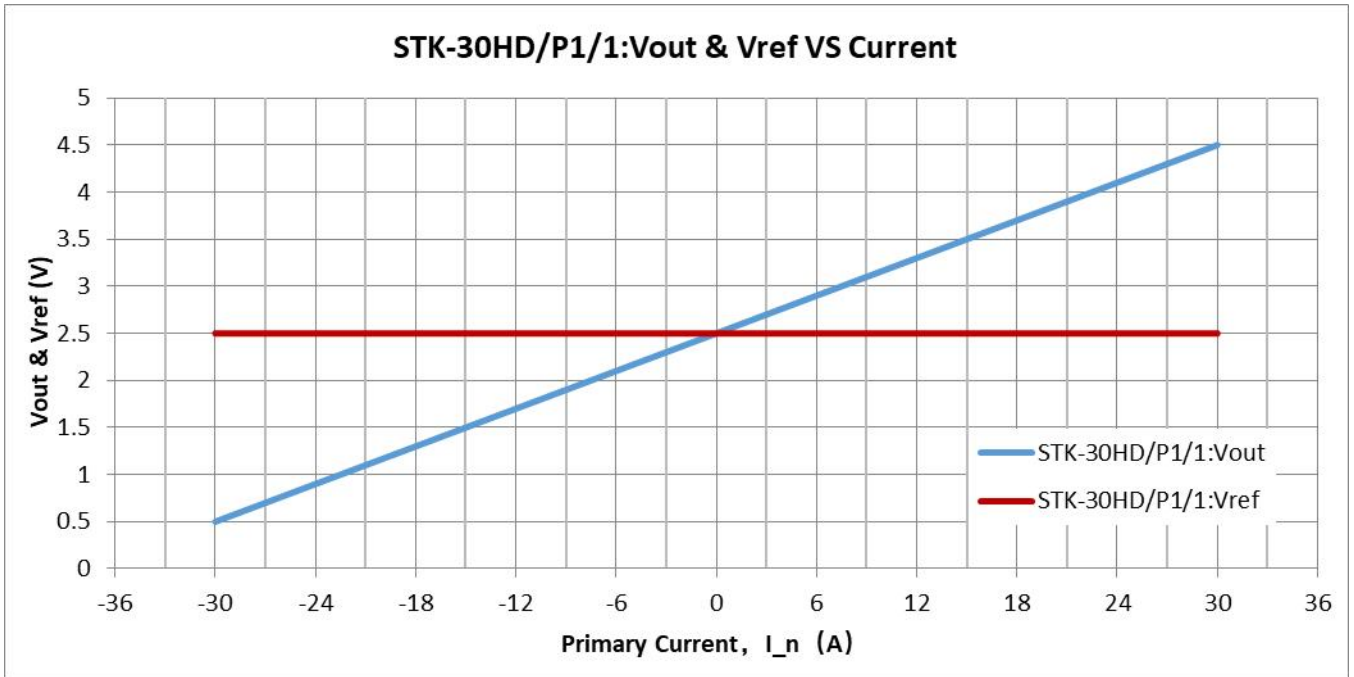

The dependence of Vout of STK-30HD/P1/1 on the primary current.

4. Electrical performance of STK-20HD/P1/1

Parameter	Symbol	Unit	Min	Typ	Max	Comment
Primary nominal current rms	I _{pn}	A		20		
Primary current measuring range	I _{pm}	A	-20		20	STK-20HD/P1/1
Supply voltage	V _{cc}	V	4.75	5	5.25	
Current consumption	I _{cc}	mA		5		
Reference voltage	V _{ref}	V	2.47	2.5	2.53	Output function
Quiescent voltage V _{out} @ 0 A	V _{off}	V	2.47	2.5	2.53	STK-20HD/P1/1
Electrical offset voltage (V _{out} – V _{ref}) @ 0 A	V _{oe}	mV	-20		20	STK-20HD/P1/1
Rated output voltage (V _{out} – V _{ref})@ I _{pn} – V _{oe}	V _{FS}	V		2		STK-20HD/P1/1
Internal output resistance	R _{out}	Ω		1		
Internal reference resistance	R _{ref}	Ω		1		
Theoretical gain	G	mV/A		100		STK-20HD/P1/1
Rated linearity error	Non-L	%I _{pn}		0.7		Within ±I _{pn}
Reaction time	t _{ra}	μs		0.5		@ 10% of I _{pn}
Step response time	t _{res}	μs		1.0		@ 90% of I _{pn}
Delay time	t _{delay}	μs		0.5		400 kHz sine wave
Frequency bandwidth (-3dB)	BW	kHz		600		No RC circuit
Output voltage noise DC ~ 10 kHz DC ~ 100 kHz	V _{noise}	mV _{pp}		15 20		@250 kHz Sampling Rate
Accuracy @ 25°C	X	% of I _{pn}	-1		1	@ 25°C
Accuracy @ -40°C~105°C	X _{TRange}	% of I _{pn}	-3		3	-40°C ~ 105°C

Remarks:

- the accuracy @ -40°C~105°C, X_{TRange} = (((V_{out} – V_{ref})@ I_n @ T_x) – V_{oe}@ 25°C – G_{th} * I_n) / V_{FS}, where T_x represents present temperature, G_{th} is fitted gain at room temperature.

5. Output voltage VS primary current of STK-20HD/P1/1

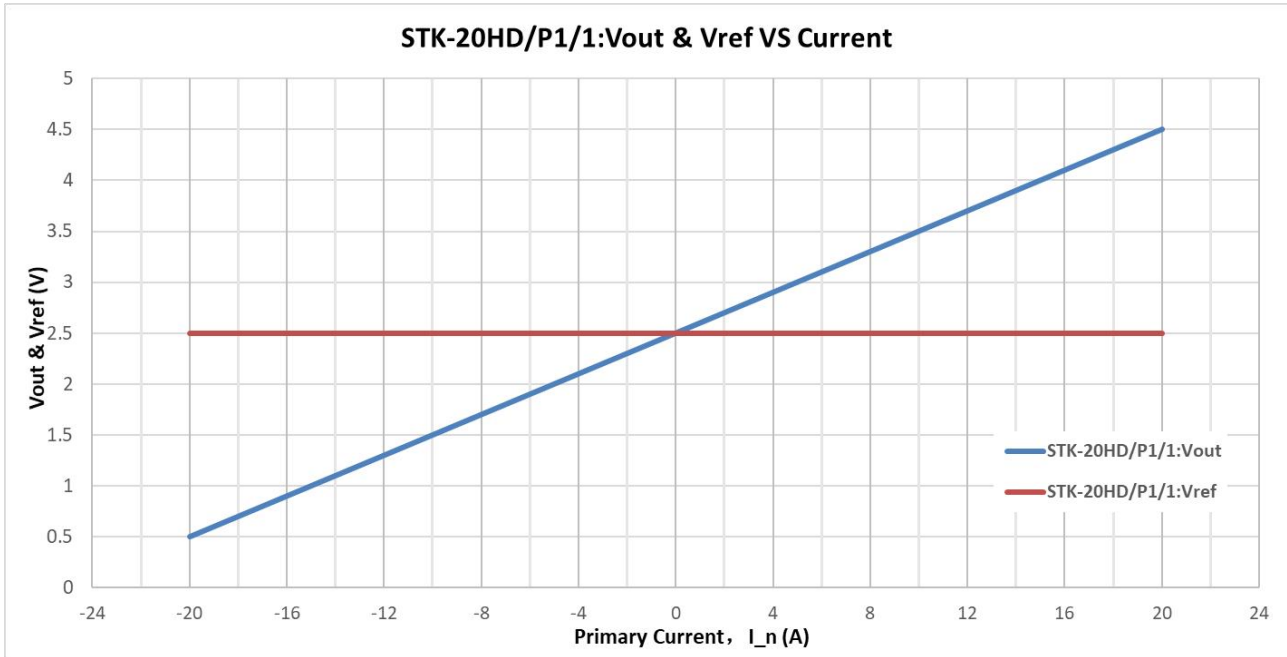

The dependence of Vout of STK-20HD/P1/1 on the primary current.

6. Electrical performance of STK-20HD/P1/2

Parameter	Symbol	Unit	Min	Typ	Max	Comment
Primary nominal current rms	I _{pn}	A		20		
Primary current measuring range	I _{pm}	A	-50		50	STK-20HD/P1/2
Supply voltage	V _{cc}	V	4.75	5	5.25	
Current consumption	I _{cc}	mA		5		
Reference voltage	V _{ref}	V	2.47	2.5	2.53	Output function
Quiescent voltage V _{out} @ 0 A	V _{off}	V	2.47	2.5	2.53	STK-20HD/P1/2
Electrical offset voltage (V _{out} – V _{ref}) @ 0 A	V _{oe}	mV	-20		20	STK-20HD/P1/2
Rated output voltage (V _{out} – V _{ref})@ I _{pn} – V _{oe}	V _{FS}	V		0.8		STK-20HD/P1/2
Internal output resistance	R _{out}	Ω		1		
Internal reference resistance	R _{ref}	Ω		1		
Theoretical gain	G	mV/A		40		STK-20HD/P1/2
Rated linearity error	Non-L	%I _{pn}		0.7		Within ±I _{pn}
Reaction time	t _{ra}	μs		0.5		@ 10% of I _{pn}
Step response time	t _{res}	μs		1.0		@ 90% of I _{pn}
Delay time	t _{delay}	μs		0.5		400 kHz sine wave
Frequency bandwidth (-3dB)	BW	kHz		600		No RC circuit
Output voltage noise DC ~ 10 kHz DC ~ 100 kHz	V _{noise}	mV _{pp}		15 20		@250 kHz Sampling Rate
Accuracy @ 25°C	X	% of I _{pn}	-1		1	@ 25°C
Accuracy @ -40°C~105°C	X _{TRange}	% of I _{pn}	-3		3	-40°C ~ 105°C

Remarks:

3. the accuracy @ -40°C~105°C, X_{TRange} = (((V_{out} – V_{ref})@ I_n @ T_x) – V_{oe}@ 25°C – G_{th} * I_n) / V_{FS}, where T_x represents present temperature, G_{th} is fitted gain at room temperature.

7. Output voltage VS primary current of STK-20HD/P1/2

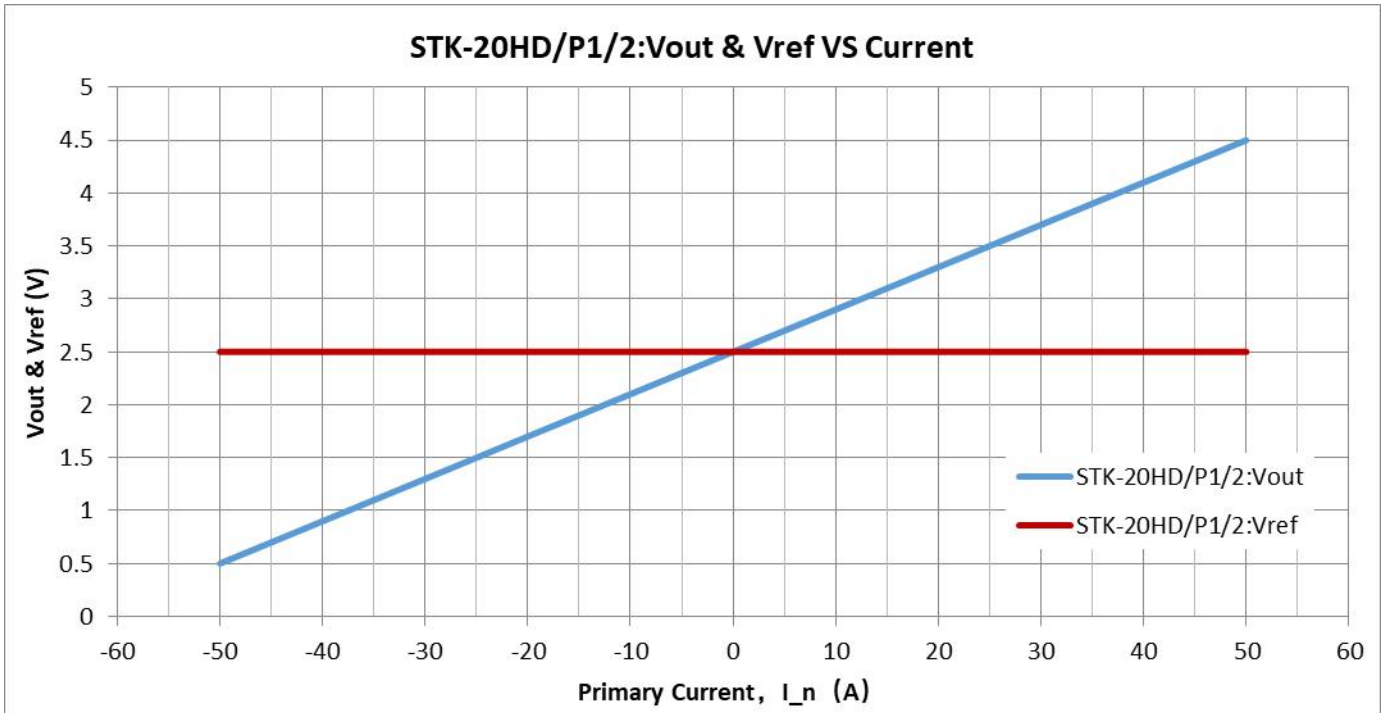

The dependence of Vout of STK-20HD/P1/2 on the primary current.

8. Frequency band width

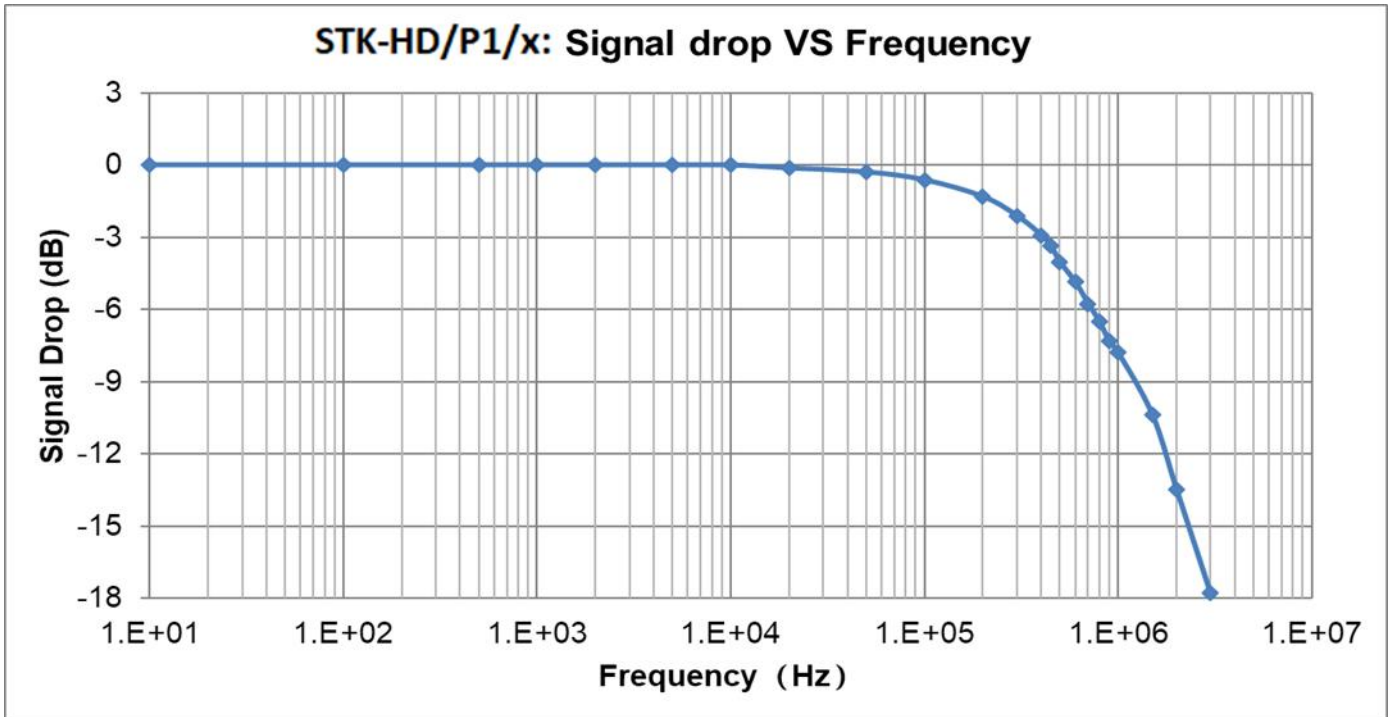

Fig.1 the frequency band width of STK-HD/P1/x series current sensors.

9. Step response time

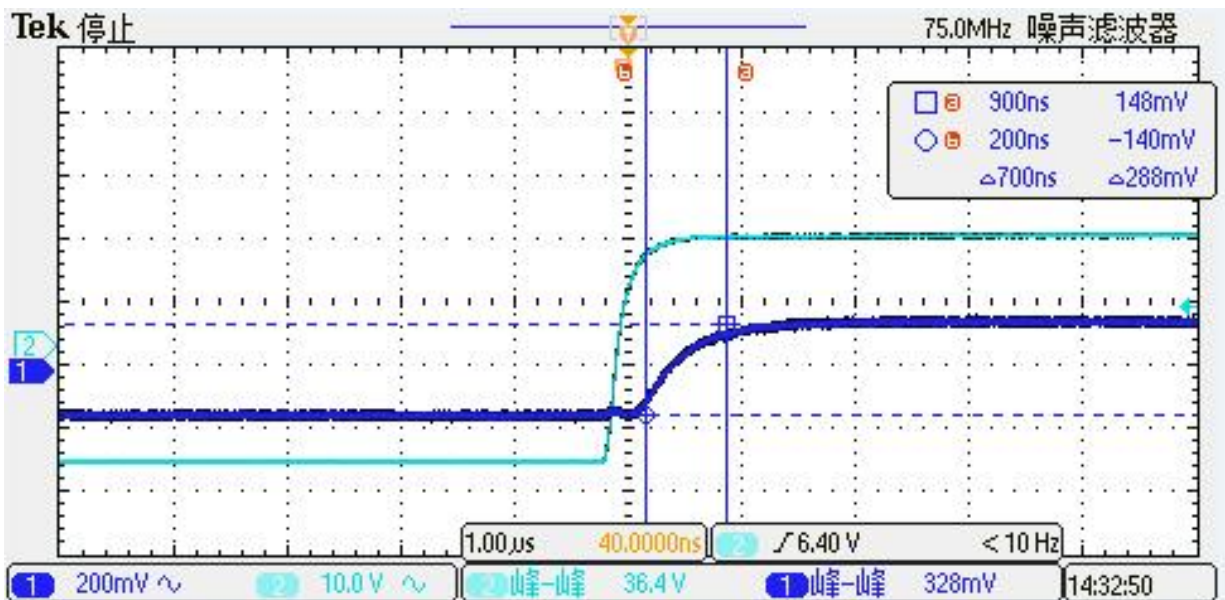

Fig.2 the step response time of STK-HD/P1/x current sensors. The light blue is primary current, while the dark blue is output signal of current sensor. The step response time is less than 1.0 μ s.

10. Delay time

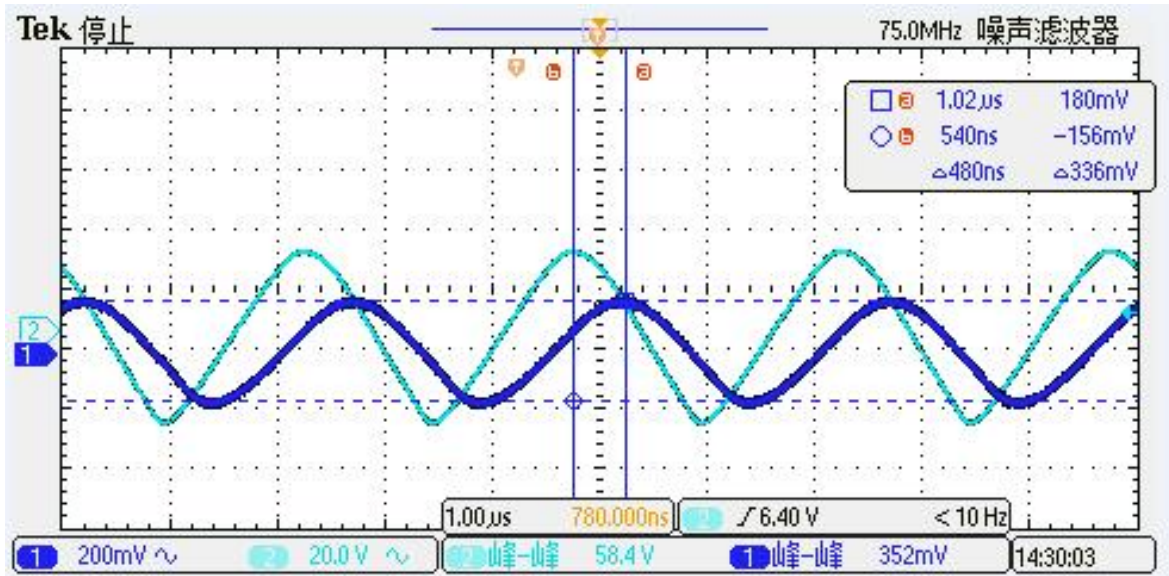
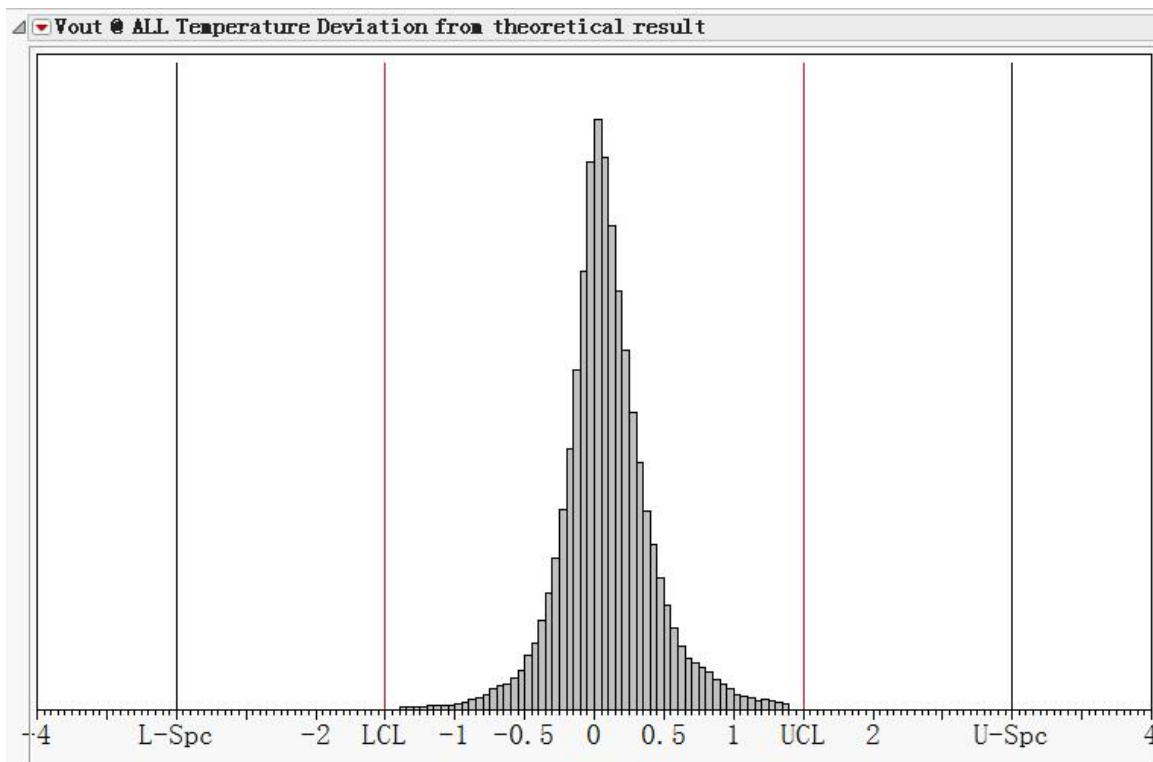
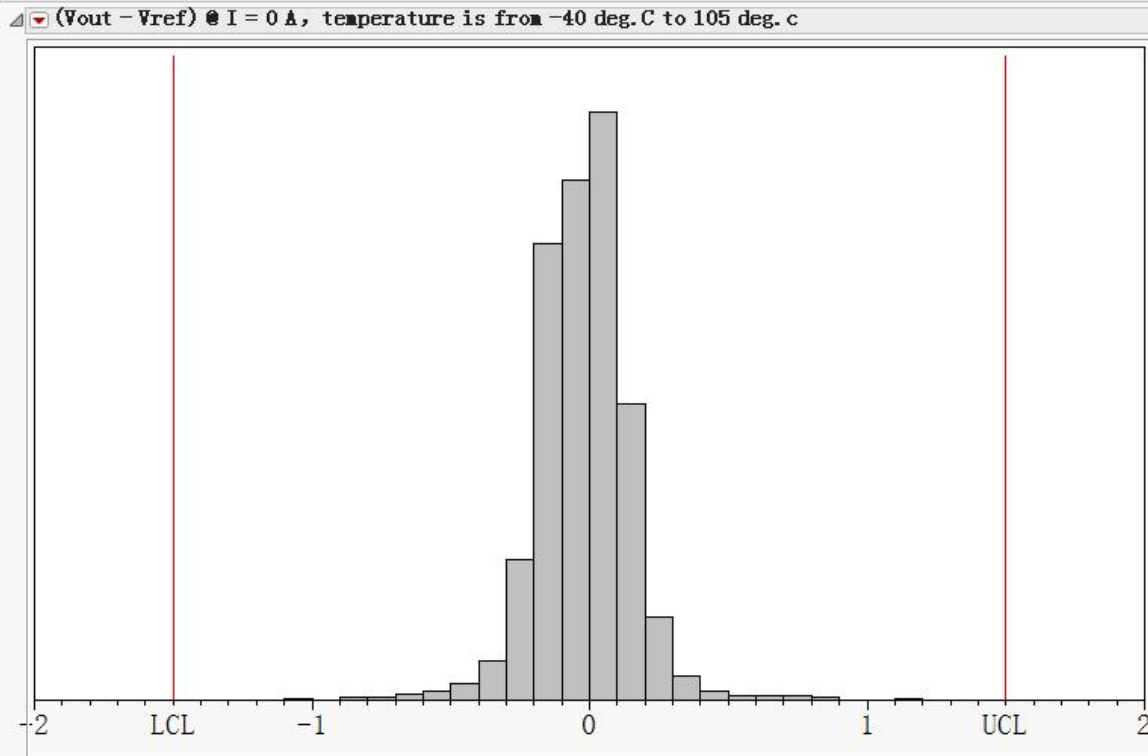

Fig.3 when detection the primary current with a frequency of 400 kHz. The delay time from the primary current (light blue) to the output of the sensor (dark blue) is around 0.5 μ s.

11. Accuracy performance



The error of $(V_{out} - V_{ref})$ (for STK-20HD/P1/x) current sensors in the temperature range of $-40^{\circ}\text{C} \sim 105^{\circ}\text{C}$ compared with the standard output $(V = G_{th} * I_n)$.



Temperature drift of Voe, $V_{oe_TRange} = (V_{oe} @ T_x - V_{oe} @ 25^\circ C) / V_{FS}$. T_x represents present temperature, V_{FS} the rated output voltage.

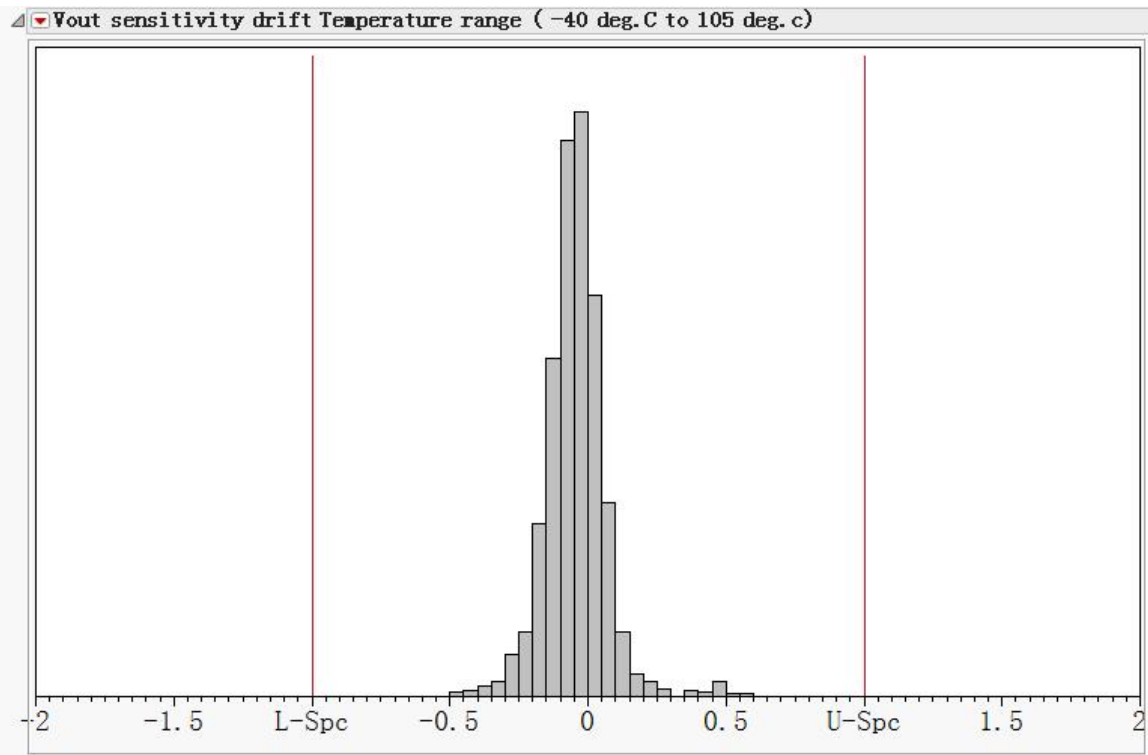

The error of gain at room temperature

12. Typical application circuits for STK-HD/P1/x

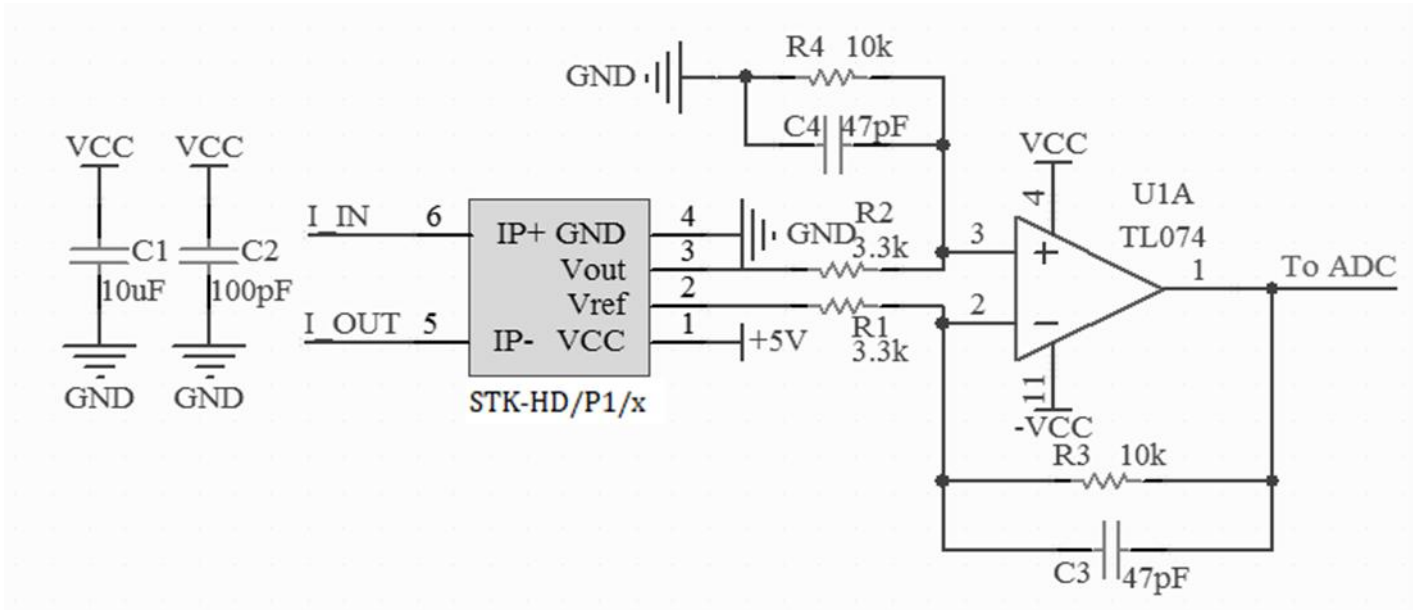

Typical application circuits for STK-HD/P1/x current sensor. The magnification can be estimated as $M = R4/R2$ with the condition of $R1 = R2$, and $R3 = R4$. The magnification in the above circuit is about 3.

R3 (kohm) = R4 (kohm)	C3 (pF) = C4 (pF)	Theoretical -3dB $f = 1/(2\pi RC)$ (kHz)	Tested -3dB (kHz)
20	20	398	~ 400
20	81	98	~ 100
20	810	10	~ 10

The frequency characteristics of STK_HD/P1/x series current sensor are not affected by the R-C setting (according to recommended R-C setting), therefore the active filter circuit or R-C circuit can be applied to modulate the sensor's frequency characteristics.

13. Dimensions & Pins & Footprint

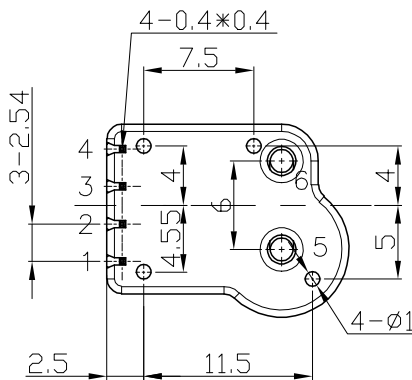
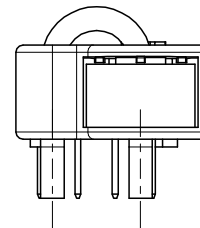
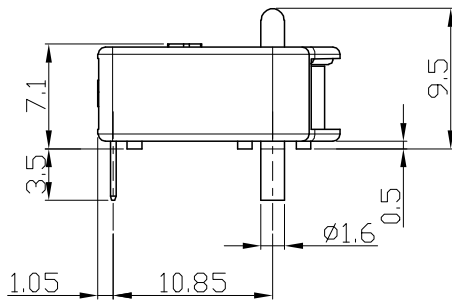
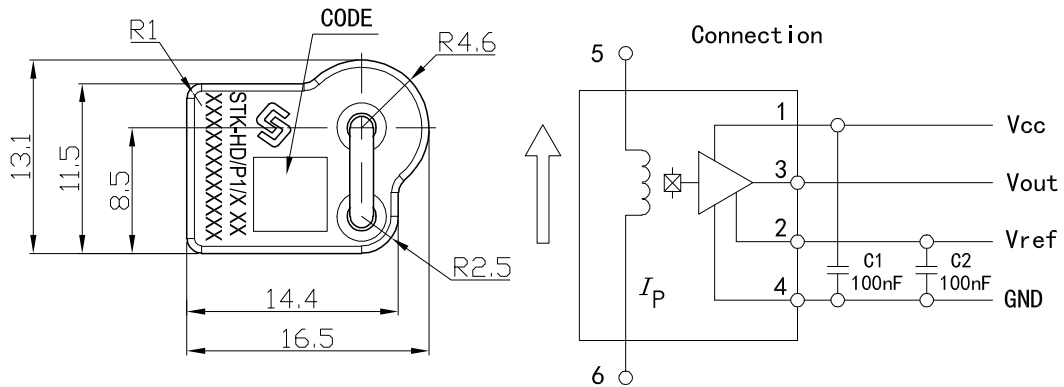

Terminals

1.	Vcc
2.	Vref
3.	Vout
4.	GND
5.	I _p -
6.	I _p +

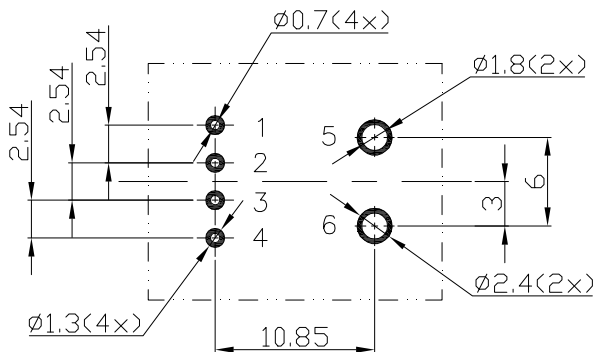

Material : Fit UL94V-0 & RoHS requirements ;
General tolerance : ±0.5
Unit :mm

